

Installation / Operation Manual Emergency Lighting Central Inverter System

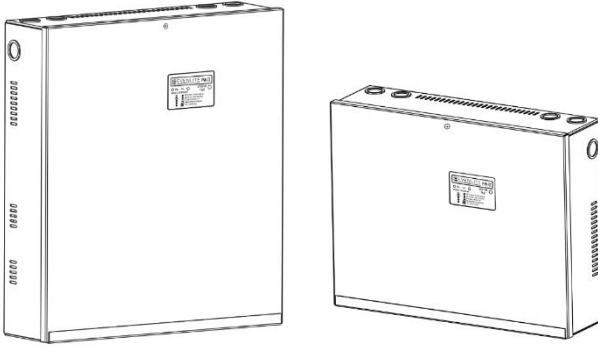

IMPORTANT SAFEGUARDS

When using electrical equipment, basic safety precautions should always be followed including the following:

READ AND FOLLOW ALL SAFETY INSTRUCTIONS

- A. Do not use outdoors
- B. Do not mount near gas or electric heaters.
- C. Use caution when servicing batteries. Battery acid can cause burns to skin and eyes. If acid is spilled on skin or in eyes, flush acid with fresh water and contact a physician immediately.
- D. Equipment should be mounted in locations and at heights where it will not readily be subjected to tampering by unauthorized personnel.
- E. The use of accessory equipment not recommended by the manufacturer may cause an unsafe condition.
- F. Do not use this equipment for other than intended use.

This unit contains lethal voltages. There are no user serviceable parts inside. Only authorized service personnel are to be used for service.

SAVE THESE INSTRUCTIONS

The installation and use of this product must comply with all national, state, municipal or local codes that apply. Please read this manual thoroughly before installing and operating the PWII Series central inverter system. For assistance please call EVENLITE technical support at 800-967-5573 and speak to a technician during normal business hours (EST).

TABLE OF CONTENTS

1.0 Introduction

- 1.1 Mechanical Design Features
- 1.2 Electrical Design Features

2.0 Receiving and Storage

- 2.1 Inspection
- 2.2 Storage

3.0 Installation

- 3.1 Location
- 3.2 Operating Environment
- 3.3 Ventilation
- 3.4 Mounting Guidelines
 - 3.4.1 Clearance
 - 3.4.2 Wall Mounting Holes
 - 3.4.3 Knockout Locations

4.0 AC Connections

- 4.1 Installing the Input Wires
- 4.2 Installing the Output Wires
- 4.3 AC Input(s) / Output(s) Diagram

5.0 Battery and DC Connections

- 5.1 Battery Inspection
- 5.2 Battery Installation
- 5.3 DC Voltage of System
- 5.4 Battery Wiring Diagram(s)

6.0 Startup and Shutdown Procedures

- 6.1 Startup Procedure
- 6.2 Shutdown Procedure

7.0 Specifications

8.0 User Interface

- 8.1 LED1 – Charging Mode and Line Status
- 8.2 LED2 – Inverter Mode and Battery Level Indication
- 8.3 Minor Alarm
- 8.4 Major Alarms
- 8.5 Startup Faults
- 8.6 Charger Faults
- 8.7 Inverter Faults

9.0 System Operation

- 9.1 Startup Mode
- 9.2 Battery Charging Mode
- 9.3 Inverter (Battery Discharge) Mode
- 9.4 AC Output Types
 - 9.4.1 Normally-On Output
 - 9.4.2 Normally-Off / Switched Output

10.0 Warranty

- 10.1 Technical Service and Support
- 10.2 Return Material Authorization (RMA)

11.0 Maintenance and Service

- 11.1 Battery Maintenance
- 11.2 Battery Replacement

12.0 Fire Alarm/Dimming Option

- 12.1 Overview
- 12.2 Operation
- 12.3 User Presets
- 12.4 Fire Alarm / Dimming Connections
- 12.5 Testing the Dimmer Option

13.0 Typical Wiring Diagrams

Diagrams 1 - 5

1.0 INTRODUCTION

The PWII Series central emergency lighting inverter system integrates the latest inverter and microprocessor technology to produce a pure sine-wave power output. With typical 3% or less steady state losses, it makes it ideal for energy saving and green initiatives. It is designed specifically for emergency lighting and meets the needs of all lighting loads with its pure sine-wave output which is the ONLY method of power that will ensure any lighting load type will be powered safely, efficiently and effectively. The PWII Series meets the Emergency Lighting Backup requirements that demand high efficiency, versatility, load compatibility, energy savings, high performance, and high quality.

1.1 Mechanical Design Features

Batteries and electronics are contained in a single cabinet which makes installation very easy. Wall mounting can be achieved with 4 mounting holes capable of accepting ¼" lag-bolts and electrical knock outs (EKO's) are available on three surfaces. Quick access to the interior of the cabinet for battery inspection and maintenance is accomplished by the removal of a single screw which holds the front cover. A single module containing all electronics can be easily removed for upgrade or replacement. This single module makes maintenance and repair easier and more cost effective because specialized training is not required.

1.2 Electrical Design Features

Through the use of Pulse Width Modulation (PWM) and the latest MOSFET technology, PWII Series can produce a pure sine-wave output which is compatible with all types of lighting loads. User selectable Input and Output voltage of either 120 VAC or 277 VAC makes for versatility with Electrical Contractors and field installations. A high crest factor of up to 10X (125W model) is extremely beneficial for high-inrush loads and also ideal for bringing Normally-Off lighting loads on from a cold start. This high crest factor also improves the dynamic response so mixing Normally-On and Normally-Off loads together causes less performance loss than traditional inverters. Since the active PWM regulation scheme produces a very low THD waveform, the PWII Series can power up even the most demanding loads driving its output with power factor capabilities ranging from 0.5 leading to 0.5 lagging.

Adding to the versatility are the multiple output types of Normally-On and the multipurpose Normally-Off/Switched outputs. These outputs are capable of switching the emergency lighting loads on and off making energy savings and green initiatives easy to accomplish and all outputs are capable of producing full output power and have no derating. The batteries are charged by a temperature compensated charger integrated into a bi-directional converter. A three rate charging scheme and bi-directional converter topology ensures maximum float life and minimal ripple current on the batteries.

2.0 RECEIVING AND STORAGE

2.1 Inspection

The PWII Series central inverter and batteries are shipped together. Upon arrival, please inspect the contents to ensure that no shipping damage has occurred. This is especially important with the batteries – ensure that there are no cracks or leaks. If any damage has occurred, notify the shipping carrier immediately and submit a damage claim.

WARNING - Do not use system with a damaged battery as this may cause an unsafe condition.

2.2 Storage

Storage before the installation is critical for the battery life expectancy and warranty. Store the system indoors in a clean, dry and cool location. Storage at higher temperatures will result in accelerated rates of self-discharge and possible deterioration of battery performance and life.

WARNING – The maximum storage time from shipment to initial charge is **6 months** for batteries stored at ambient temperatures no warmer than 77°F (25°C). For storage temperatures greater than 77°F (25°C) the batteries must be recharged one (1) month sooner for every 5°F (3°C) increase above 77°F (25°C).

Storage at high temperatures will result in accelerated rates of self-discharge and possible deterioration of battery performance and life. Storage times exceeding the above may result in plate sulfation, which may adversely affect electrical performance and expected life.

***Failure to install and charge the batteries as noted
VOIDS the battery's warranty***

DANGER - Batteries present a risk of electrical shock and high short circuit current. Do not smoke, cause a flame or spark in the immediate are of the batteries. Use proper lifting means when moving batteries and wear all appropriate safety clothing and equipment.

3.0 INSTALLATION

3.1 Location

NEC article 700 EMERGENCY CIRCUITS should be referenced for proper installation of a central inverter system. Article 700 dictates that unit must be mounted in a permanent location. Choose a cool dry place with normal ventilation and one which will allow easy access for testing and maintenance. Avoid a location which could allow vandalism and tampering with. Avoid areas that would prohibit visual contact with the heads up LED status displays.

3.2 Operating Environment

Choose a location that is controlled between 20 and 30 °C. PWII Series is UL listed between 20°C to 30°C (68°F to 86°F) because of battery discharge performance results. Do not install in a wet or damp location. Do not install in environments that will expose the unit to excessive temperatures like boiler rooms as this will significantly depreciate battery life.

Heat is the determining factor of battery life. Every means should be made to keep the batteries in an environment that keeps the batteries around 25 °C for rated battery life.

3.3 Ventilation

Choose a mounting location that is clean and dust free. Do not install in areas where there is particulate or high pollution degree from heavy industrial machinery, corrosive chemicals or welding or plasma cutting environments etc.

3.4 Mounting Guidelines

3.4.1 Clearance

PWII Series is convection cooled and air ventilation is through the sides and up the top. Leave at least 4 inches of clearance on the sides and top for proper air circulation.

WARNING - Never leave objects lying on the top of the unit which would prevent proper air flow. This blocking of air circulation may result in an over-temperature fault during Charging Mode or Inverter Mode with high ambient temperature conditions.

3.4.2 Wall Mounting Holes

Mounting holes are provided for Wall Mount purposes. The location of these holes are at the back side of the cabinet and will accommodate ¼" mounting hardware. Four holes are provided and all 4 should be used when wall mounting.

3.4.3 Knockout Locations

Electrical Knock Outs are provided on three surfaces of the PWII Series. Ensure all metal conduit is secured and tightened creating a good connection to earth ground. Use an Ohm-Meter to check that continuity between conduit and protective earth ground has been established.

WARNING – Drilling into cabinet may void warranty if metal filings causes unit failure.

Wall-Mount Hole Locations – PWII Series 125W

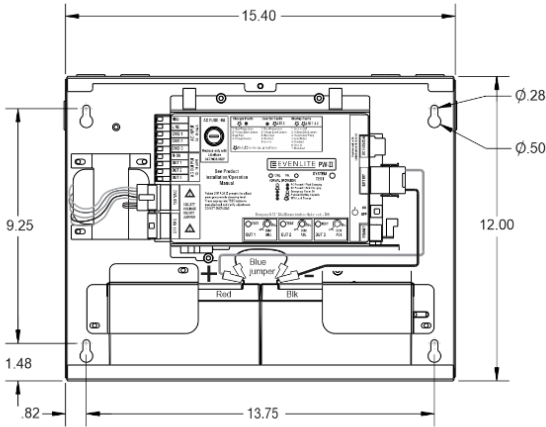

Wall-Mount Hole Locations – PWII Series 250W

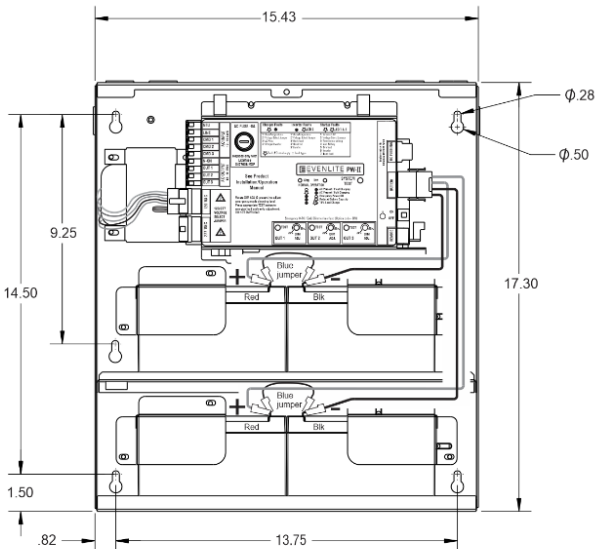

Knockout Locations – PWII Series 125W

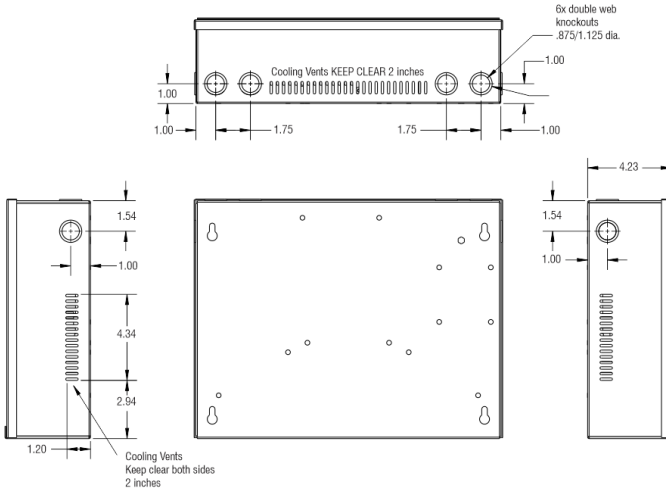

Knockout Locations – PWII Series 250W

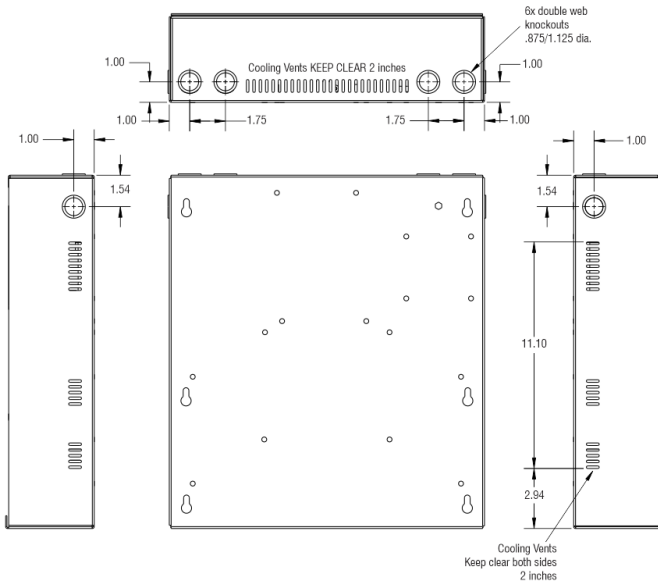

4.0 AC CONNECTIONS

WARNING – Only qualified personnel that are familiar with AC and DC installation techniques and codes (such as an electrician) should perform the Installation.

WARNING – The PWII Series contains lethal AC Voltages. Because of these hazards of high voltage electrocution, always shut down all sources of power before you install, maintain, or service the unit.

WARNING – Remove all rings, watches, and other jewelry before doing any electrical service or installation work. Always wear protective clothing and appropriate personal protective equipment (PPE) that is suitable such as eye protection when working near batteries.

4.1 Installing the Input Wires

Once the front cover is removed,

1. Ensure that the incoming AC voltage to the PWII Series the same voltage rating as the VOLTAGE SELECT JUMPER. Remove and re-insert to the correct location if needed.
2. Ensure that the feed breaker from the panel has enough ampacity to allow for the full rating of the load connected to the PWII Series.

Once Feed Voltage and VOLTAGE SELECT JUMPER match and breaker size is correct,

1. Connect the Utilities Feed Line voltage to the Terminal Block LINE and NEU (Neutral). Ensure that the wire connections to the terminal block are tight by briefly tugging the wires.
2. Connect CMD 1, CMD 2 and CMD 3 if Switched Outputs are required. See section 9.4 thru 9.4.2 for further load type details.

NOTE – AC Input and AC output wires must be run in separate conduit or raceways per NEC ARTICLE 700. Please ensure all codes and standards are observed.

NOTE – PWII Series requires that the Neutral and Ground potential does not exceed 5 VAC for proper function. Anything above 5 VAC typically indicates that there may be a grounding issue or inadequate conductor size or continuity. This should be looked at immediately as it could cause a safety concern.

NOTE – Neutral and ground should never be tied together anywhere in the PWII Series. Always keep Neutral and Ground wires separate and ensure no shorts occur.

NOTE – Neutral (NEU) in the PWII Series is common to both the Input and Output. Never mix Neutrals for the building wiring (Non-Emergency) with the Emergency wiring. Dedicated wiring is required by NEC code ARTICLE 700.

4.2 Installing the Output Wires

Connect the load wires to the Normally-On output leads labeled N-ON, or the multipurpose Normally-Off/Switched outputs OUT 1, OUT 2 or OUT 3. Ensure that the wire connections to the terminal block are secured by briefly tugging the wires. See section 9.4 thru 9.4.2 for further load type details.

- 1 Ensure that the System ON/OFF switch is in the OFF position before starting.
- 2 Connect 120 VAC or 277 VAC to the AC INPUT terminals LINE and NEU. System ground should be connected directly to the cabinet's green grounding screw.
- 3 Ensure that the connected AC INPUT line voltage matches the VOLTAGE SELECT JUMPER. Remove and re-inserting the plug to the correct position if necessary.
- 4 Connect the load wires to the AC OUTPUT terminals. Load types can be either Normally-On (N-ON) which are always energized 24/7, or multipurpose Normally-Off/Switched. OUT 1, OUT 2 and OUT 3 are controlled by CMD 1, CMD 2, and CMD 3 respectively when used as Switched load types. If no connections are made to the CMD 1-3, the OUT 1-3 will act as a Normally-Off load type and will only energize during the Inverter mode of operation (Loss of utility power or system test). See section 9.4 thru 9.4.2 for additional details on load types.

4.3 AC Input(s) / Output(s) Diagram

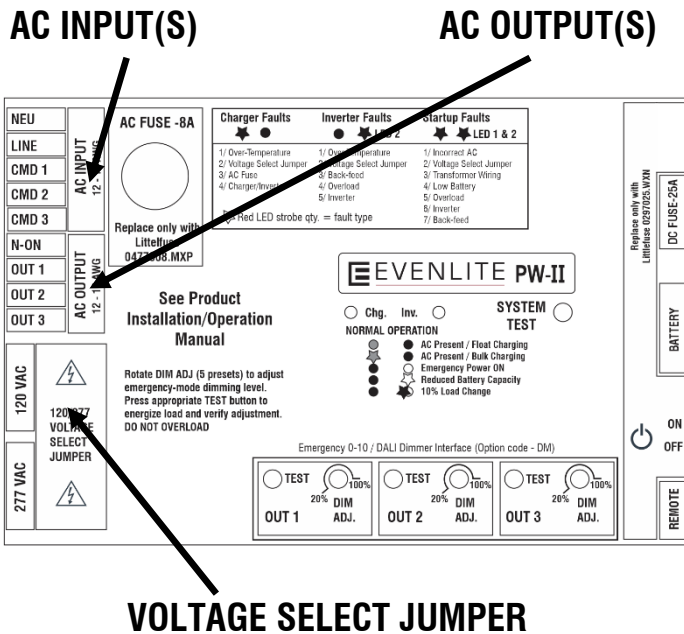

5.0 BATTERY AND DC CONNECTIONS

WARNING – Only qualified personnel that are familiar with AC and DC installation techniques and codes (such as an electrician) should perform the Installation.

WARNING – Remove all rings, watches, and other jewelry before doing any electrical service or installation work. Always wear protective clothing and appropriate personal protective equipment (PPE) that is suitable such as eye protection when working near batteries.

WARNING - Batteries contain tremendous energy and can explode if short circuited. Precautions should be taken to eliminate possible short circuits. Do not install batteries until unit is completely mounted and secured in a permanent location with all conduit and AC wiring connected.

5.1 Battery Inspection

Inspect the batteries for any physical damage such as cracks or any other sign of leaking electrolyte. Batteries contain Sulfuric Acid which is highly corrosive. A leak from a battery will cause an unsafe condition.

5.2 Battery Installation

The PWII Series batteries may come pre-installed and pre-terminated to the main DC Battery Connector. If battery connections must be made, follow detail in section 5.4 for the appropriate model you have.

Tip - It is best to insert the jumper between both batteries before the batteries are fully inserted into the supporting shelf. After ALL DC connections have been made, insert the battery cable assembly's multi-pin connector into the mating plug on the right side of the PWII Series electronics module. See section 5.4 for detailed illustrations.

5.3 DC Voltage of System

The systems DC battery voltage for the PWII Series is 24VDC for both 125W and 250W models. This voltage is produced by connecting two 12V batteries in series for the 125W model and a series parallel connection for the 250W model.

All required cables are provided by the manufacturer and may come pre-installed on the batteries (model dependent). All batteries connect to a wiring harness in a fail-safe manor to accomplish the system's DC voltage requirements.

NOTE – Battery potential does not have galvanic isolation from AC potential. Battery Negative is tied to Neutral.

6.0 STARTUP AND SHUTDOWN PROCEDURES

6.1 Startup

After the AC input and output wires are connected and the battery connector is properly installed, the unit is ready to be started up.

Ensure that the incoming AC voltage is reaching the unit by turning on all feed circuit breakers. Once AC input is verified, simply turn on the System ON/OFF switch. The unit will go through a series of diagnostics to verify proper connections and then will go into the charge mode. The unit is now on-line and ready. Verify that all load connections are operating within the specifications of the unit by measuring AC currents on both the line and load and measure all neutral currents to ensure line and neutral currents are the same.

Press the Test button on the front panel to verify that the multipurpose Normally-Off/Switched outputs are all operational and ensure there are no overloads by measuring the currents.

If alarms occur during start-up, see section 8.5 thru 8.7 for possible explanations. Also see section 9.1 for Start-Up Mode explanations.

6.2 Shutdown

To shut the system completely down simply place the System ON/OFF switch to the off position. If the unit is shut down for a long duration please see Battery Storage Section 2.2 to ensure that the batteries are not damaged from the effects of self-discharge and high ambient temperatures.

7.0 Specifications

The PWII Series system can be overloaded during normal operation when the dimming option is used. The maximum allowable connected load for both the 125W and 250W model is 375W. The system must be tested to ensure that the connected load power does not exceed the systems rated power (125W/250W) while in the Inverter Mode of operation.

Maximum Connected Load with Dimming Option

375W

7.0 Specifications (cont.)

Input

Voltage	120 or 277 VAC – User Selectable
Current	2.7A (120V), 1.2A (277V) for 250 Watt Model 1.4A (120V), 0.6A (277V) for 125 Watt Model
Frequency	60Hz +/- 2 Hz
Protection	Easy access 8A fast acting 5x20 mm fuse.
Power Factor	0.5 lead to 0.5 lag

Output

Voltage	120 or 277 VAC – User Selectable
Current	2.08A (120V), 0.9A (277V) for 250 Watt Model 1.04A (120V), 0.45A (277V) for 125 Watt Model
Frequency	60Hz +/- 0.02 Hz crystal controlled during emergency mode
Overload	110 percent will generate overload fault
Transfer Time	50mS standard (Optional 1 Second)
Output Distortion	Less than 3% THD
Crest Factor	10X for 125W and 5X for 250W model
Load Power Factor	0.5 lead to 0.5 lag
Output Types	1x Normally-On, 3x Multipurpose Normally-Off/Switched

Battery

Type	Premium Long Life Valve-Regulated Lead Acid (VRLA)
Charger	3 rate with Temperature Compensation
Recharge Time	24 Hour recharge standard
Protection	Automatic Low Voltage Disconnect (LVDD) set at 1.67 VPC Automatic restart upon utility return
Runtime	90 Minutes at 25 °C
DC Voltage	24 VDC Nominal, 2.26 VPC float, temperature compensated
DC Current	6.2/12.4 ADC Nominal for 125W/250 Watt model respectively

Environmental

Operating Temp	20 to 30 °C
Storage Temp	-20 to 70 °C (Electronics) 0 to 40 °C (Batteries)
Relative Humidity	<95 % (non-condensing)

Physical

Cabinet	NEMA Type 1 enclosure, 16 AWG powder painted CRS
Cooling	Natural Convection – No fans
Size/Weight	15.4W-12H-4.25D / 33lbs. (125W Model) 15.4W-17.3H-4.25D / 57 lbs. (250W Model)

8.0 USER INTERFACE

There are two heads-up LEDs to indicate system status and a recessed test button to initiate the inverter to run in Inverter Mode. Both LED1 and LED2 are bi-color LED's and will illuminate either solid, blinking, or change between colors for different modes of operation or faults. There are two distinct fault levels – Minor and Major. A Minor alarm will not cause the system to suspend output and will operate although the fault exists. A Major alarm will cause the system to cease all outputs and will need to be reset. If a Major alarm exists, it must be identified and fixed before the system can be operated. To reset the Major Alarm, simply press the System Test button and the system will start its self-testing diagnostics to verify the fault has been cleared.

8.1 LED1 – Charging Mode and Line Input Status

When the LED1 is illuminated green, the system is charging the batteries and the AC is present. If LED1 is solid green, the batteries are fully charged or near fully charged. If the LED1 is blinking green, the batteries are being charged at a high capacity and they are not at the float voltage level yet. When the LED1 is red, it is an alarm/fault condition.

8.2 LED2 – Inverter Mode and Battery Level Indication

When the LED2 is illuminated yellow, the system is running on Inverter Mode. If the LED2 is solid Yellow, the voltage of the battery is above 11.4 and 22.8 for 12 and 24 VDC systems respectively. If the LED2 is blinking Yellow, the battery voltage is getting low and has less than 30 minutes of run time left. When LED2 is red, it is in an alarm/fault condition.

8.3 Minor Alarm

The systems minor alarm occurs while in Inverter Mode if a load change has been detected. The system will automatically store the operating output current when it transfers to Inverter Mode after five seconds. It will then actively compare the stored value against the current value. If the current value of the load current deviates by more than 10 percent high or low, it will generate a load change alarm – which is a Minor Alarm. If this alarm is present, the LED2 will blink between a Yellow and Red color.

8.4 Major Alarms

The system Major alarm can occur on three distinct modes – System Start-Up Mode, Charge Mode and Inverter Mode. Major Alarms are latching faults which must be addressed and the system must be reset by either pressing the System Test button or by a power cycle reset – turning the System ON/OFF switch off and then back on.

8.5 Start-Up Faults

During power on and initialization, the system goes through a series of checks to prevent hardware failures which can occur from common wiring or installation errors. If Faults are discovered during the start-up sequence, **LED1 (Charger) and LED2 (Inverter) will both illuminate red** and will blink a specific quantity which correlates to the fault type. Listed below are the fault types and the blink quantities associated with each of the fault types. To clear the fault, press the system test button after problem was diagnosed/repared which initiates a new system start-up.

INCORRECT AC (LED1/LED2 – 1 Blink)

Indicates that the incoming AC voltage does not match the VOLTAGE SELECT JUMPER position. Simply remove the jumper and connect to the correct location.

VOLTAGE SELECT JUMPER (LED1/LED2 – 2 Blinks)

Indicates that the VOLTAGE SELECT JUMPER is not inserted. Insert jumper to the correct location so that the Incoming AC voltage matches the VOLTAGE SELECT JUMPER location.

TRANSFORMER WIRING (LED1/LED2 – 3 Blinks)

Indicates that the blue and yellow wires for the main transformer are reversed.

LOW BATTERY (LED1/LED2 – 4 Blinks)

Indicates that the battery voltage is incorrect or too low to start the system. Check the connectors and wiring of the batteries and measure the DC voltages to ensure they are above 12V.

OVERLOAD (LED1/LED2 – 5 Blinks)

Indicates that there is too much load connected or there is a short circuit. Check the connected load wiring and/or reduce the connected load to the power of the inverter's rating.

INVERTER (LED1/LED2 – 6 Blinks)

Indicates that there is fault with the Inverter module.

BACKFEED (LED1/LED2 – 7 Blinks)

Indicates that there is an AC voltage back-feeding the output terminals. This fault means that the PWII Series was wired incorrectly between the output terminal and the load(s).

8.6 Charger Faults:

While the batteries are being charged, the system will continuously check for faults as part of its diagnostic capabilities. **LED1 (Charger LED) will illuminate red** and will blink a specific quantity which correlates to the fault type. Listed below are the fault types and the blink quantities associated with each of the fault types. To clear the fault, press the system test button after problem was diagnosed/repared which initiates a new system start-up.

OVER TEMPERATURE (LED1 – 1 Blink)

Indicates that the MOSFET's Heatsink temperature has exceeded its limits. This fault will clear itself after it cools down so no reset is required.

VOLTAGE SELECT JUMPER (LED1 – 2 Blinks)

Indicates that the VOLTAGE SELECT JUMPER is not inserted. Insert jumper to the correct location so that the Incoming AC voltage matches the VOLTAGE SELECT JUMPER.

AC FUSE (LED1 – 3 Blinks)

Indicates the AC fuse has blown. Check for overloads and wiring errors and replace fuse.

CHARGER/INVERTER (LED1 – 4 Blinks)

Indicates that there is a fault with the Charger/Inverter module.

8.7 Inverter Faults:

While the batteries are being discharged in the Inverter Mode, the system will continuously check for faults as part of its diagnostic capabilities. **LED2 (Inverter LED) will illuminate red** and will blink a specific quantity which correlates to the fault type.

Listed below are the fault types and the blink quantities associated with each of the fault types. To clear the fault, press the system test button after problem was diagnosed/repared which initiates a new system start-up.

OVER TEMPERATURE (LED2 – 1 Blink)

Indicates that the MOSFET's Heatsink temperature has exceeded its limits. This fault will clear itself after it cools down so no reset is required.

VOLTAGE SELECT JUMPER (LED2 – 2 Blinks)

Indicates that the VOLTAGE SELECT JUMPER is not inserted. Insert jumper to the correct location so that the Incoming AC voltage matches the VOLTAGE SELECT JUMPER location.

BACKFEED (LED2 – 3 Blinks)

Indicates that there is AC voltage already at the output terminals back-feeding into it. This fault means that the PWII Series was wired incorrectly between the output terminal and the load. Since this fault was already checked at power up, it is possible that there is a remote transfer device which is back-feeding during Inverter operation.

OVERLOAD (LED2 – 4 Blinks)

Indicates that there is too much load connected or there is a short circuit. Check the connected load wiring and/or reduce the connected load to the power of the inverter's rating.

INVERTER (LED2 – 5 Blinks)

Indicates that there is fault with the Inverter module.

LVD (LED2 – 6 Blinks)

Indicates that the inverter ran on battery until the Low Voltage Disconnect (LVD) point. This fault will only be present for 1 minute and then the system will turn itself off.

9.0 SYSTEM OPERATION

9.1 Startup Mode

When the PWII Series is first turned on using the System ON/OFF switch, it goes through a sequence of self-tests which ensures proper connections are made and it also checks for faults that may be present. The inverter must qualify several things before advancing to the Battery Charging mode. There will be two distinct clicks of relays as it goes through the self-check sequence. After all the Start-Up diagnostics are performed, the PWII Series is OK to proceed to the Battery Charging mode.

9.2 Battery Charging Mode

The Battery Charging mode is where the system will remain for most of the products life. In this mode, AC power is being passed from the INPUT AC through to the OUTPUT AC and subsequently its loads are being powered and the internal battery charger is maintaining a float charge. The charger is regulating or floating the batteries at 2.26 Volts per Cell (VPC) and is temperature compensated to 4mV per deg. C (per cell), centered at 25 °C. For higher temperatures, float voltages go down. For lower temperatures, float voltages go up.

The PWII Series nominal DC battery voltage is 24 VDC for the 125 and 250W model. The system float voltage is set to 2.26 VPC which corresponds to 27.12 VDC for both 125W and 250W models.

Low Voltage Disconnect (LVD) is set to 1.67 VPC or 20.1 VDC for both the 125W and 250W models. Float voltage varies with temperature, LVD voltage is fixed.

Typical voltages that the PWII Series charger would float the batteries are:

10 Deg. C	27.84 VDC
15 Deg. C	27.60 VDC
20 Deg. C	27.36 VDC
25 Deg. C	27.12 VDC
30 Deg. C	26.88 VDC
35 Deg. C	26.64 VDC
40 Deg. C	26.40 VDC

Above 40 °C no additional compensation is performed.

9.3 Inverter Mode

Inverter Mode can have several other names such as Emergency Power and Battery Power Mode. This terminology may be used throughout this document.

During Inverter Mode, the inverter is producing a pure sine wave for the output loads and the batteries are being discharged. The output current is limited by an active pulse by pulse current limit technique and prevents the inverter from failure.

In the event of an overload there are several ways that the inverter will protect itself. First is the pulse by pulse limit and second is by average sensing. The pulse by pulse is a transient protection and occurs in the micro-second time scale, the average sensing looks at a heavily filtered signal and occurs in the seconds time scale.

Since the crest factor is very high on the PWII Series, loads that have high inrush currents are quickly up and running. This is very beneficial with Switched or Normally-Off loads. The Normally-On and multipurpose Normally-Off/Switched outputs all produce voltage during Inverter Power mode.

9.4 AC Output(s) Types

9.4.1 Normally-On Output

There is one Normally-On Output located on the terminal block and is labeled N-ON. The Normally-On Output is energized 24/7 as long as the system is powered on.

9.4.2 Normally-Off/ Switched Output

There are three multipurpose Normally-Off/Switched outputs (OUT 1, OUT 2 and OUT 3) which can be energized on and off during the charging mode of operation. These outputs are controlled by applying an AC voltage to the Switched Command Input CMD 1, CMD 2 and CMD 3 respectively. These output types function as an interface to energy saving controls such as time clocks, daylight harvesting, photo-sensors or any building occupation sensing.

NOTE - When the PWII Series changes mode of operation from Charge Mode to the Inverter Mode, **ALL** output types will automatically energize regardless of the state of the Switched Command Input.

10.0 WARRANTY

There are two separate warranty periods for the PWII Series Central Inverter System. The Electronics/Cabinet warranty period is for 3 years from the date of shipment. It is warranted against defects in workmanship and materials under normal and proper use. Batteries are covered under a separate warranty and these durations may change dependent on type. Please see www.evenlite.com for complete warranty terms.

BATTERY TYPE	WARRANTY DURATION
Premium VRLA	3 years full, 7 years pro-rata

10.1 Technical Service and Support

Our technical support staff is available before, during, and after the installation for help on any detail of this product. Should you need help, please contact our service center at:

Service Center

1-800-967-5573

We are available during normal business hours Eastern Standard Time Zone.

10.2 Return Material Authorization (RMA)

At no time will material be accepted as returned goods without a RMA number issued from the factory. If parts are deemed defective by our Technical Service group and are troubleshot at the site to be defective they can be exchanged at no cost during the warranty period with an RMA.

When returning defective parts back to the factory, the RMA number must be written on the packaging, bill of lading, or shipping labels so it can be properly identified.

Technical Service will make every effort to troubleshoot the problem over the phone before an RMA will be issued. Phone troubleshooting may save both the customer and manufacturer added time and expense. Cooperation is greatly appreciated.

11.0 MAINTENANCE AND SERVICE

CAUTION – Whenever maintenance and service is to be performed, it may be desirable to shut unit down. Please refer to Start up and Shut Down procedures for details.

CAUTION – Always assume AC and DC Voltages are present at the PWII Series terminals because the inverter is capable of providing output voltage from the batteries when there is no AC input. The unit can pass through AC voltages from input to output with no batteries connected if the installation switch is on.

Routine Maintenance

Routine Maintenance should be considered any maintenance that does not require removing the Inverters' front cover panel. This maintenance includes periodic cleaning of dust from the cover and cabinet base to ensure proper convection air flow. Since no fans are required on this system, air flow moves by convection. Convection air circulation is from bottom to top as heat naturally rises.

Keep all foreign objects off the top and away from the sides of the unit as these may impede convection air flow.

PWII Series automatically performs monthly tests (every 28 days). PWII Series has a self-clearing 28 day counter and resets any time the unit transferred to the Inverter Mode. If on day 14 the unit had a brief power outage, the counter gets reset and 28 days later (pending no other transfers) a monthly test would be performed.

A quick test by manually pressing the test button will transfer the system to the Inverter Mode and will turn on all the connected loads such as the multipurpose Normally-Off/Switched load.

Ensure there are no faults present. If there are faults, please refer to the User Interface section for a complete detail of what this fault may indicate.

Monthly Test - By pressing the TEST button on the front panel, the unit will transfer to the Inverter Mode. This test will run for at least 15 seconds and will exit back to Battery Charging upon synchronizing to utility power.

Yearly Test - The NFPA code requires that a yearly test of 90 minutes be performed and the system must be able to run the full 90 minutes without going into a LVD fault.

A yearly test of 90 minutes can be initiated by holding in the TEST button for 5 seconds. An alternate method of performing the 90 minute yearly test would be to turn off the input feed breaker for the 90 minutes and then re-apply when the 90 minute duration is complete.

11.1 Battery Maintenance

The batteries used in the PWII Series are sealed lead calcium and are termed "Maintenance Free". This term may be misleading because ALL batteries require periodic maintenance even if it only consists of a visual inspection. We recommend the following maintenance plan:

- Once every 6 months the batteries should be visually inspected for cracks, leaks, bulging or deformities and corrosion buildup on terminals.

11.2 Battery Replacement

PWII Series is a UL approved and listed component with exact battery requirements. Failure to replace the batteries with the exact same type will VOID the UL approval. For battery replacement, please call the service number listed in the warranty section so that the unit performs as it was intended.

To remove the batteries, shut the unit completely down by turning off the System ON/OFF switch and remove AC power Feed source by turning off the input circuit breaker. Disconnect the Battery Connector from the PCB before removing the inverter assembly. Remove the Inverter Assembly by removing the 4 nuts that attach it to the cabinet. Carefully remove the connectors from the batteries, remove the battery brackets with a nut driver or socket extension and then lift the batteries out of the cabinet.

TIP – If the batteries are to be replaced, discharging the batteries by running in the Inverter Mode can be beneficial. First, it verifies the batteries need replacing if it does not make 90 minutes of discharge time. Second, it depletes the battery which reduces the fault current. By running the battery to LVD, the available fault current would be substantially less and safer if an inadvertent short circuit were to happen during the removal or transportation process to the recycling facility.

WARNING – Only qualified personnel that are familiar with AC and DC installation techniques and codes should perform the removal and replacement.

WARNING – Remove all rings, watches, and other jewelry before doing any electrical service or installation work. Always wear protective clothing and appropriate personal protective equipment (PPE) that is suitable such as eye protection, etc. when working with batteries.

WARNING - Batteries contain tremendous energy and can explode if short circuited. Precautions should be taken to eliminate possible short circuits.

WARNING – Batteries contain lead. Follow all local and state requirements for battery disposal. Please dispose of properly by recycling.

WARNING – Always use the correct tools with insulated handles and wear the appropriate personal protective equipment (PPE) required for battery work.

DO NOT TOUCH BATTERIES UNLESS TRAINED OR KNOWLEDGEABLE!

All means must be taken to prevent an inadvertent short circuit - ensure that all lugs are secure and insulated after removal from the batteries post. If the short circuit creates a welded lug so that the short circuit remains conducting current, the battery may explode.

Extreme danger and bodily injury can be caused by primary and secondary effects of the short circuit. Primary effects could include burns, vision or hearing loss. Secondary effects could be falling off a ladder or other sustaining injuries.

To install new batteries, see section 5.0 Battery and DC Connections.

12.0 Fire Alarm/Dimming Option

12.1 Overview

The Fire Alarm/Dimming Module option provides interface into a fire alarm system with 12-24V (AC or DC) and three independent zones of 0-10V/DALI low voltage dimming for Emergency Lighting. This option allows light levels Emergency Mode to be different than Normal Mode. When used in conjunction with the inverters Switched Outputs (which controls the Line Voltage AC Power to the fixtures) the dimming interface module will automatically transfer the low voltage dimming signals to a user preset state between full output (no dimming) and 20 percent dimming levels.

When the Fire Alarm's signal is present, OUT1-3 will energize and the dimming signal sourced from the DIMMABLE EMERGENCY FIXTURE'S LED driver will transfer to the USER PRESET levels.

12.2 Operation

The Dimming Module provides 3 independent channels of 0-10V/DALI control signals for use in Emergency Lighting. A simplified block diagram of one channel is as follows:

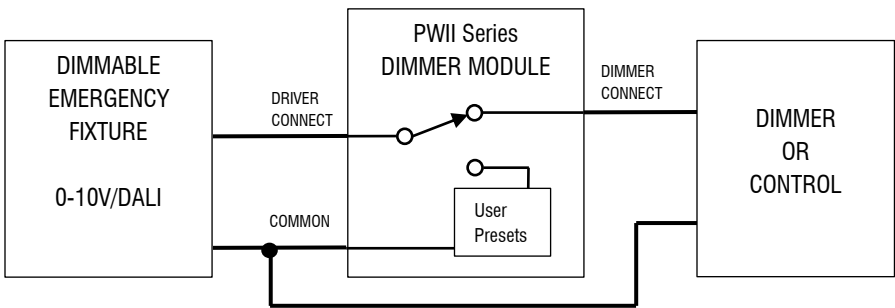

During normal operation, the DIMMABLE EMERGENCY FIXTURE is connected directly to the DIMMER OR CONTROL through the DIMMER MODULE's internal signal relay. Upon loss of power or during a system test, the DIMMER MODULE's internal relay changes state so that the User Presets (5 presets 100% - 20%) will assume control of the dimming level for the DIMMABLE EMERGENCY FIXTURE.

The DIMMER MODULE is not to be used for line voltage and is only intended for low voltage signals less than 20 VDC, 200 mA. User Presets are reverse-polarity protected and do not source current – they can only sink current.

DIM 1, OUT1 and CMD 1 all work together as a zone. CMD 1 controls OUT 1 to turn on and off with a line voltage signal during normal operation (charge mode). Also during this time, the DIMMABLE EMERGENCY FIXTURE is connected directly to the DIMMER OR CONTROL through the DIM 1 control relay.

During Emergency or Inverter mode of operation, the OUT 1 automatically energizes from the Inverter and the DIM 1 internal relay transfers to the DIM 1 USER SETTINGS. The DIMMABLE EMERGENCY FIXTURE will automatically change light levels during Emergency or Inverter Mode to the USER PRESET value.

DIM 2, OUT 2, CMD 2 and DIM 3, OUT 3, CMD 3 also work as independent zones.

12.3 User Presets (DIM ADJ)

There are 5 user presets (when using 0-10V interface) which can be changed by rotating the DIM ADJ. either clockwise (CW) for brighter and counter clockwise (CCW) for dimmer. The furthest CW rotation is an Open Circuit or 100% light level and the furthest CCW rotation is about 1V or 10% dimming level. The User Presets are current dependent which means that the values will change depending upon how much current the Dimmer Module has to sink. Provided below is a typical V/I Relation curve for the different USER PRESET positions with various LED driver current levels. 100% levels are not shown (open circuit) as these are only Position 1-5 dimming levels.

TIP - If the DIM ADJ. is set to provide 100% light levels to the fixture, the gray (common) wire is not needed. The gray wire is a current return path for the driver and is only required when dimming to light levels lower than 100%.

TIP – The TEST Button on the DIM 1, DIM 2 and DIM 3 circuits will cause the internal signal relay to switch to the USER PRESET value. This is very helpful to adjust the DIM1-3 signal and check for illumination and power consumption levels.

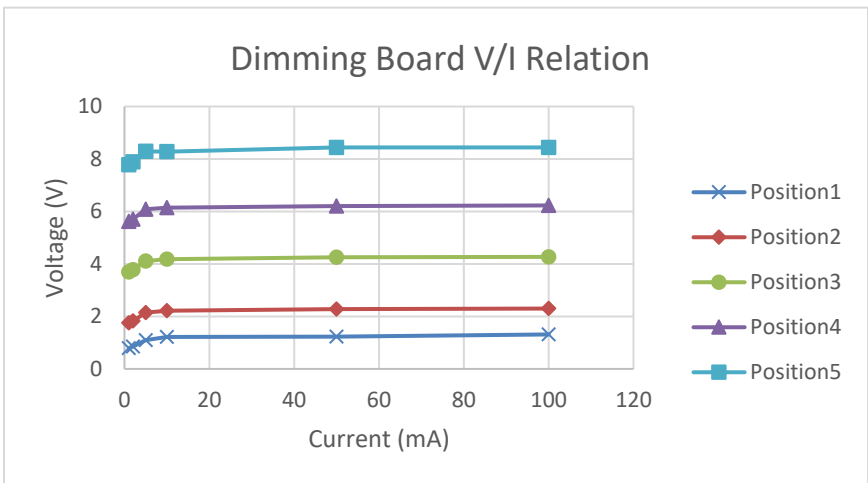

12.4 Fire Alarm/Dimming Connections

For convenience, the manufacturer provides removable connectors for both the dimming and the fire alarm interface. These connectors allow easier wiring for the installer since it can be terminated outside the equipment and then plugged in.

For the Fire Alarm function, apply 12-24V AC/DC to the 2 position connector J3. For the Dimming Interface connect DALI/0-10V violet wires into the connector J1 – please observe DRIVER and DIMMER positions on the terminal block since this matters when using any dimming level other than 100%.

DRIVER is connected to the DIMABLE EMERGENCY FIXTURES, DIMMER is connected to the DIMMING OR CONTROL signal. Please see section 12.2 for detailed signal flow.

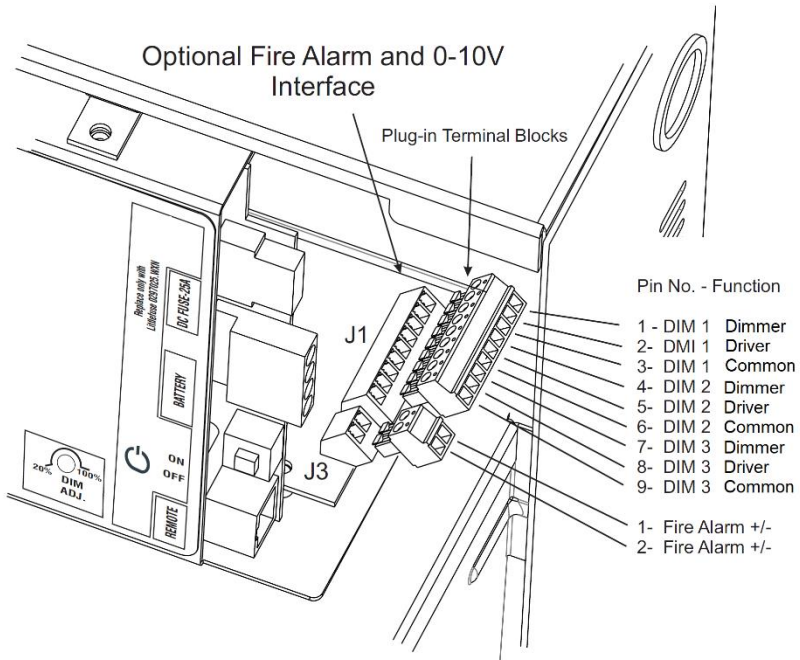

NOTE - DALI interface requires the DIM ADJ. to be in the furthest Clockwise (CW) so that the relay opens during Inverter Mode of operation. Dimming requires a DALI signal which the PWII Series does not provide.

Mini-Inverter w/ Dimming Interface Option

Wiring Diagram with 0-10V Dimming
Emergency Lights and Normal Lights

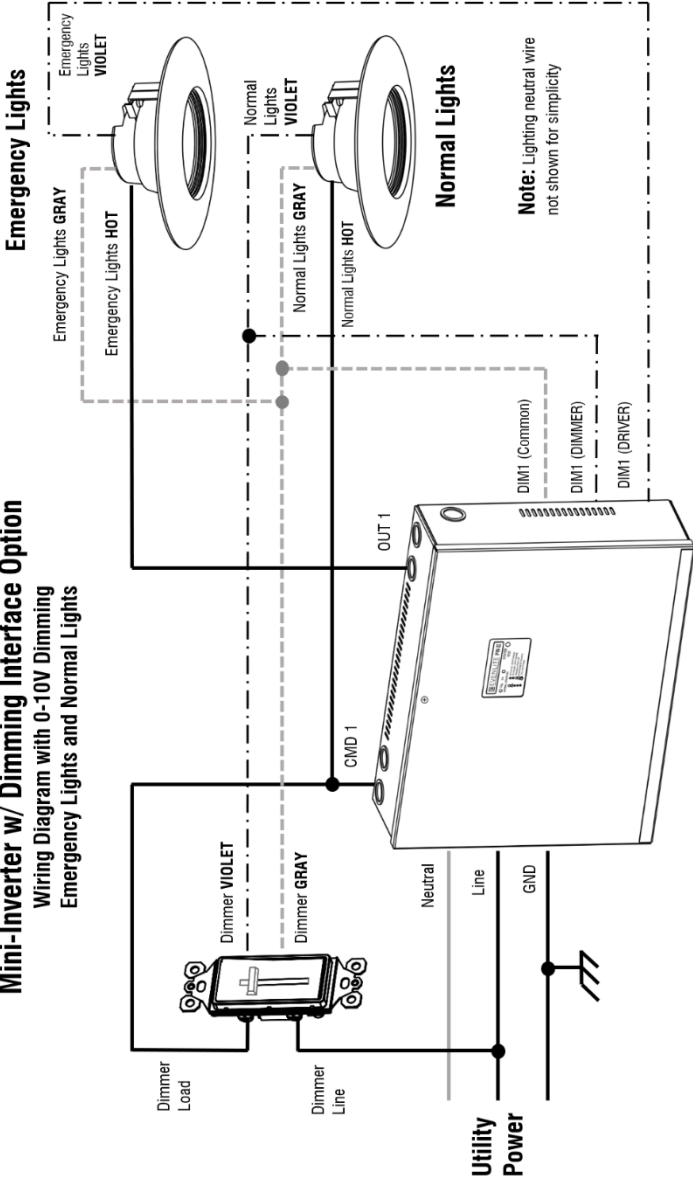

Switched Command

Line Voltage signal
 CMD 1 (120-277 VAC)
 instructs respective
 output OUT 1 ON / OFF

Switched Output

Turns ON / OFF as
 instructed by its
 respective Switched
 Command CMD 1. Will
 automatically energize
 in Inverter Mode
 regardless of the state
 of CMD 1.

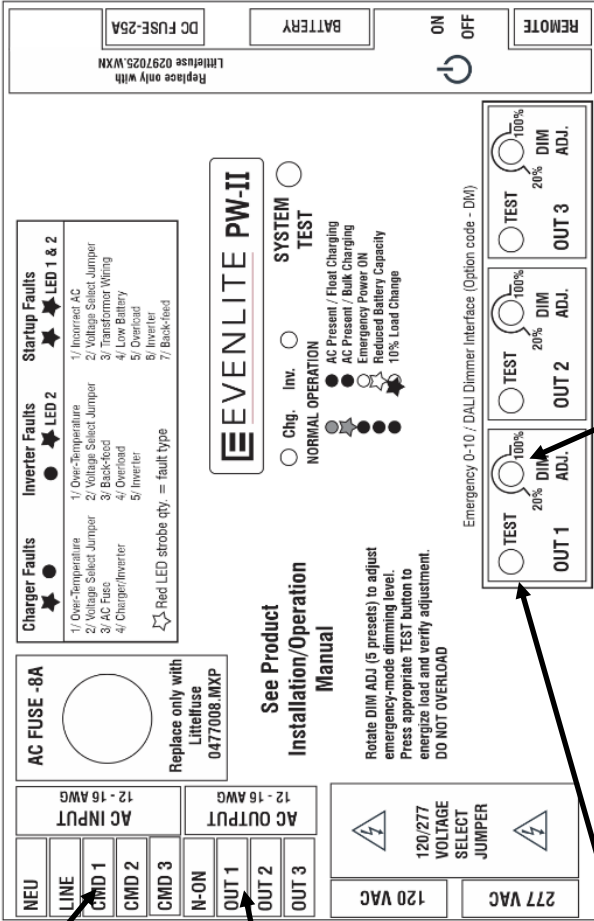

TEST

Pressing this TEST button in the Charge Mode will transfer DIM 1 signal to its pre-set value determined by DIM ADJ.

DIM ADJ.

There are 5 preset dim levels in addition to full brightness. Adjust the DIM ADJ. clockwise (CW) for brighter Emergency Lights and counter-clockwise (CCW) for dimmer Emergency Lights.

TEST button does not function in Inverter Mode.

12.5 Testing the Dimmer Option:

Once the system is completely wired, a full test should be performed to ensure proper dimming level and ensure that the system is not overloaded during Inverter Mode. To test the system, we recommend that a current clamp-on is used to measure OUT 1-3 current levels during the Charging Mode.

During Charging Mode, the Emergency Light fixture are controlled by the dimmer since the 0-10 V signal is connected through the small signal control relay contacts. Measure the current on OUT 1-3 and ensure that the sum of all the outputs do not exceed the Inverters ratings.

By pressing each circuits respective TEST button the Emergency Lights will be controlled by the Dimming Option. The dimming level can be adjusted to full brightness if the DIM ADJ. is rotated fully clockwise (CW) or can be dimmed by rotating the DIM ADJ. counter clockwise (CCW). Measure the current on OUT 1-3 and ensure that the sum of all the outputs do not exceed the Inverters ratings.

Finally, press the SYSTEM TEST button to ensure all lights are illuminated and that there are no faults when running in Inverter Mode.

Charger Mode Operation

While utility power is present, the Inverter is in the charging mode. DIM 1 DRIVER is connected directly to DIM 1 DIMMER through a small signal relay – this allows for the Normal Lights and the Emergency Lights to be controlled from the Dimmer. CMD 1 instructs the OUT 1 to turn on/off.

Inverter Mode Operation:

When the Inverter senses a utility power loss, it transfers to the Inverter Mode. DIM 1 DRIVER is disconnected/isolated from DIM 1 DIMMER by a small signal relay – this allows the Normal Lights to be disconnected/isolated from the Emergency Lights. The Emergency Lights will go to full brightness or to a preset level adjusted internally in the Inverter. AC Output OUT 1 is energized regardless of the state of the CMD 1.

Terminology

Charger Mode:

Utility Power is present and Inverter is charging the batteries.

Inverter Mode:

Utility Power is not present (Emergency) which signals the inverter to provide output power and discharges the batteries.

13.0 Typical Wiring Diagrams

DIAGRAM #1

Input Power

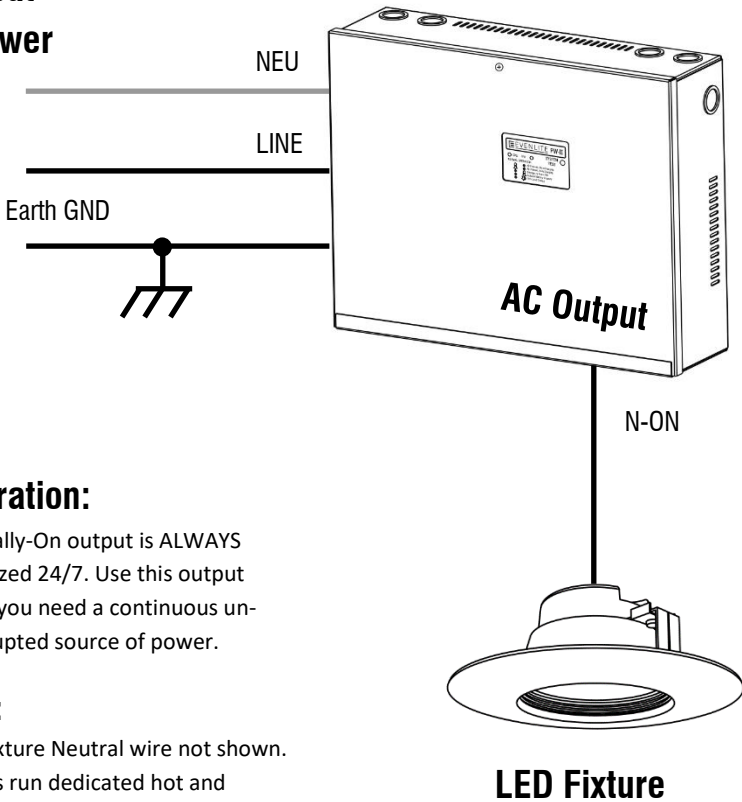

Operation:

Normally-On output is ALWAYS energized 24/7. Use this output when you need a continuous un-interrupted source of power.

Note:

LED Fixture Neutral wire not shown. Always run dedicated hot and neutral wires to emergency fixtures per NEC code.

Wiring Diagram showing Normally-On Output

Use for Night-Lights or any other 24/7 Illumination requirements such as downstream ELCD transfer devices.

DIAGRAM #2

Input Power

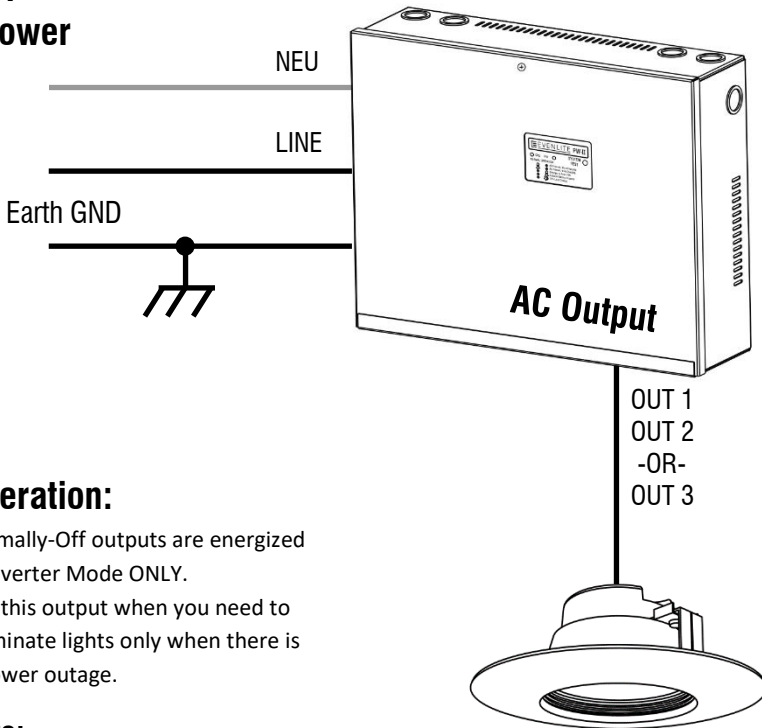

Operation:

Normally-Off outputs are energized in Inverter Mode ONLY.

Use this output when you need to illuminate lights only when there is a power outage.

Note:

LED Fixture Neutral wire not shown. Always run dedicated hot and neutral wires to emergency fixtures per NEC code.

Wiring Diagram Using Normally-Off Outputs

Use when Lights are energized ONLY during Inverter Mode of operation

DIAGRAM #3

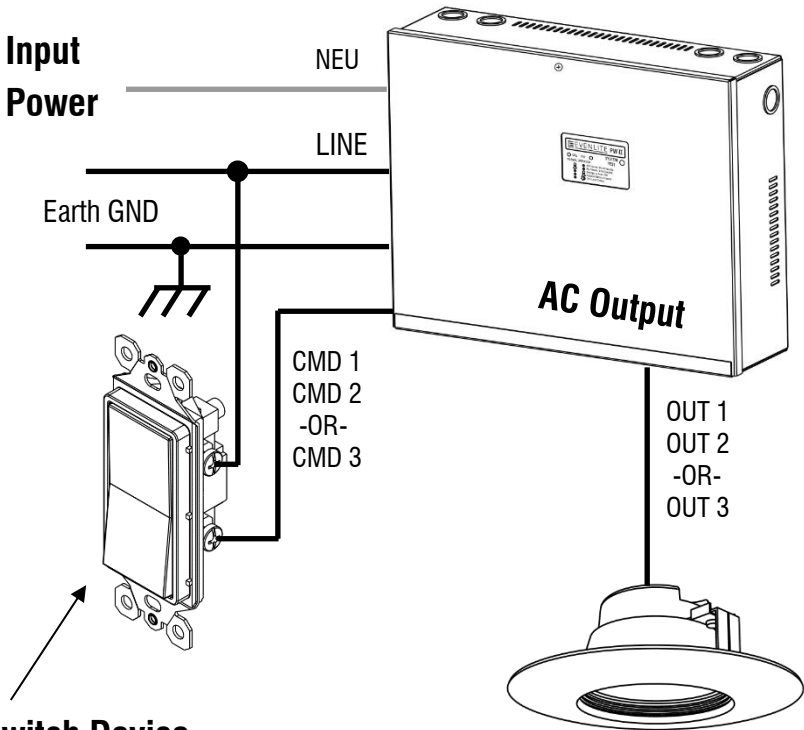

Switch Device (NO DIMMERS)

Operation: Use Switched Command(s) CMD 1, CMD 2, or CMD 3 to energize lights connected on OUT 1, OUT 2 or OUT 3 respectively.

Note: Load side of the switch can also be connected to the normal lights to create a complete lighting zone.

LED Fixture

Note:

LED Fixture Neutral wire not shown. Always run dedicated hot and neutral wires to emergency fixtures per NEC code.

Wiring Diagram Using Switched Outputs

Use when turning lights on/off

DIAGRAM #4

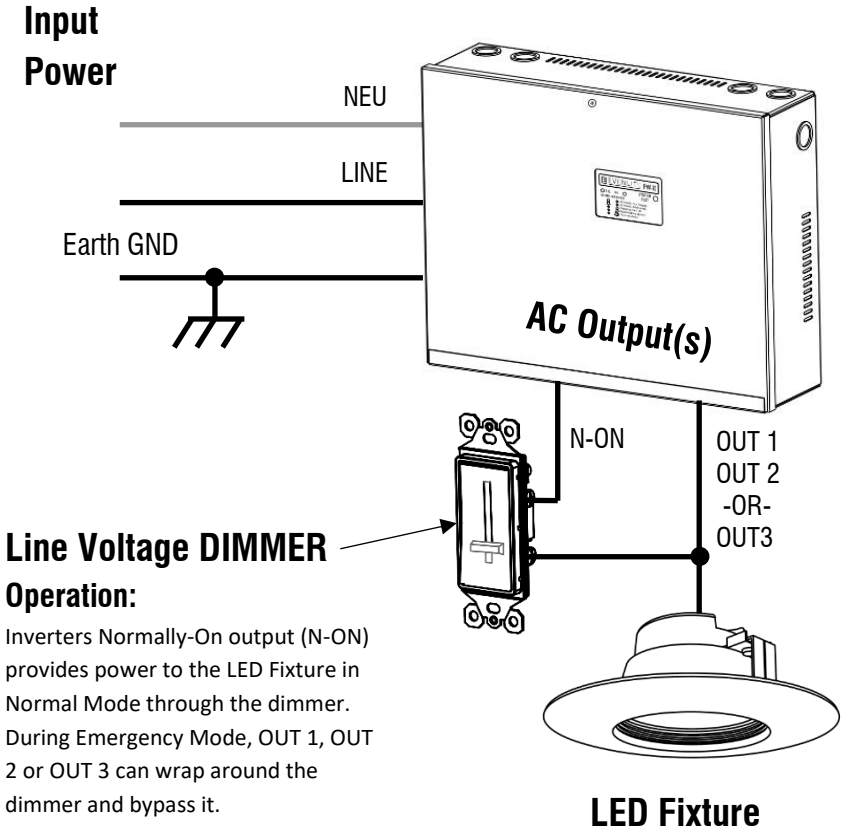

Operation:

Inverters Normally-On output (N-ON) provides power to the LED Fixture in Normal Mode through the dimmer. During Emergency Mode, OUT 1, OUT 2 or OUT 3 can wrap around the dimmer and bypass it.

Caution:

Do not overload or back-feed the inverter with this type of configuration.

Note:

LED Fixture Neutral wire not shown. Always run dedicated hot and neutral wires to emergency fixtures per NEC code.

Wiring Diagram Using Line Voltage Dimming

Use when line dimming from Normally-On and bypass with OUT 1, OUT 2 or OUT 3 during Inverter Mode

DIAGRAM #5

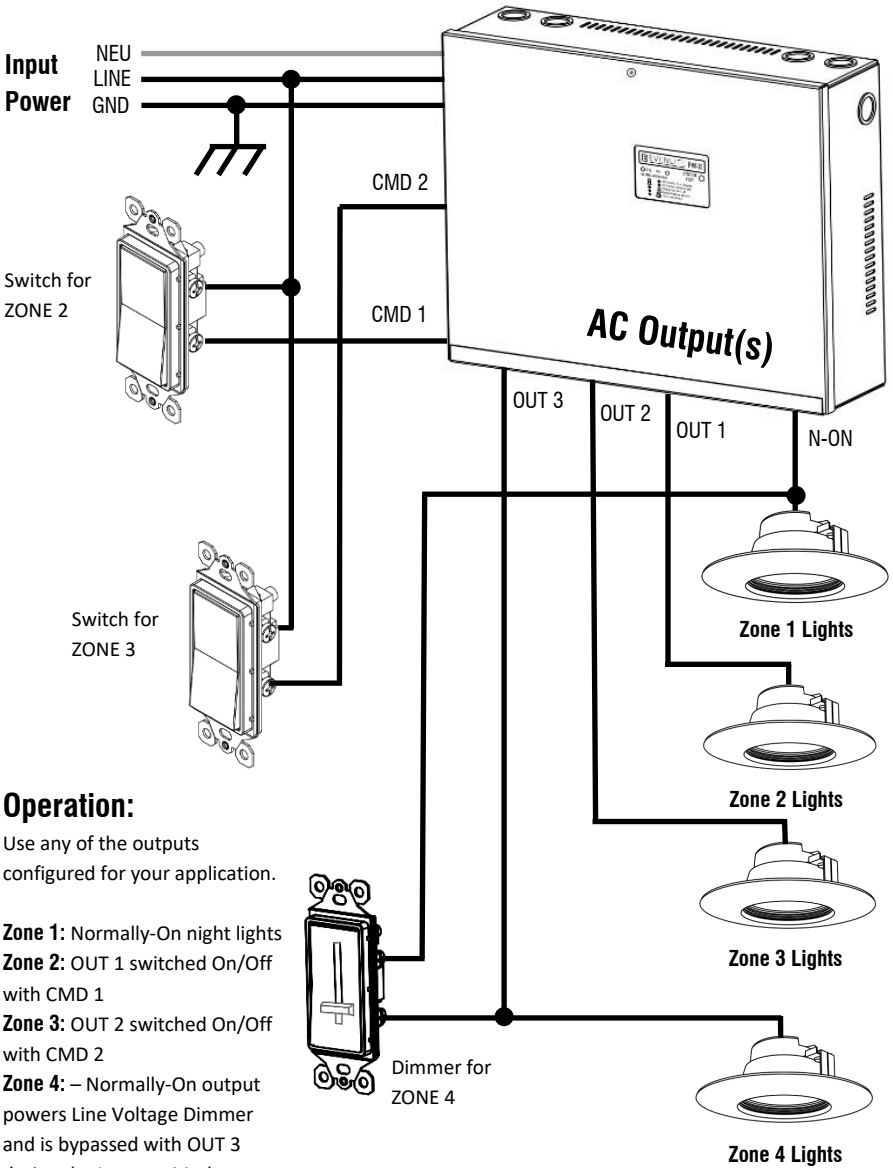

Operation:

Use any of the outputs configured for your application.

- Zone 1:** Normally-On night lights
- Zone 2:** OUT 1 switched On/Off with CMD 1
- Zone 3:** OUT 2 switched On/Off with CMD 2
- Zone 4:** – Normally-On output powers Line Voltage Dimmer and is bypassed with OUT 3 during the Inverter Mode.

Wiring Diagram Using Multiple Outputs

Mix and match various outputs to suit your application!